

SERIAL NUMBER: Q/KR.C09-05-186

JIANGMEN KREALUX ELECTRICAL APPLIANCES CO., LTD				MODEL NO: P02-3			
DRAWN		DATE		EDITION	A	SCALE	2:1

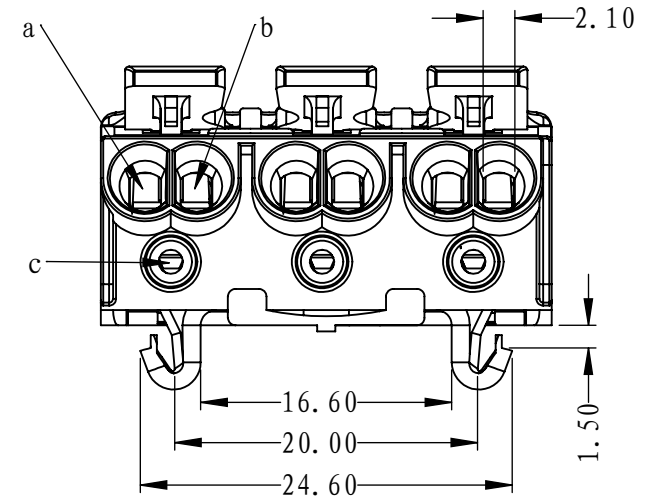
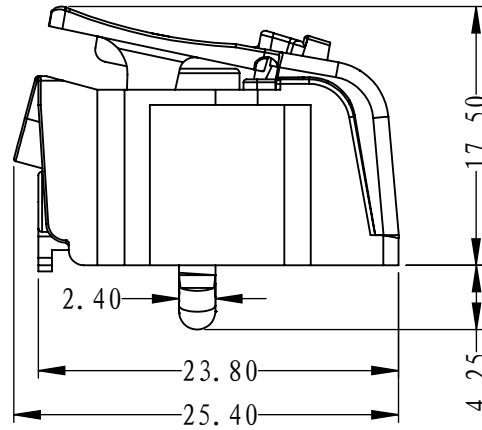
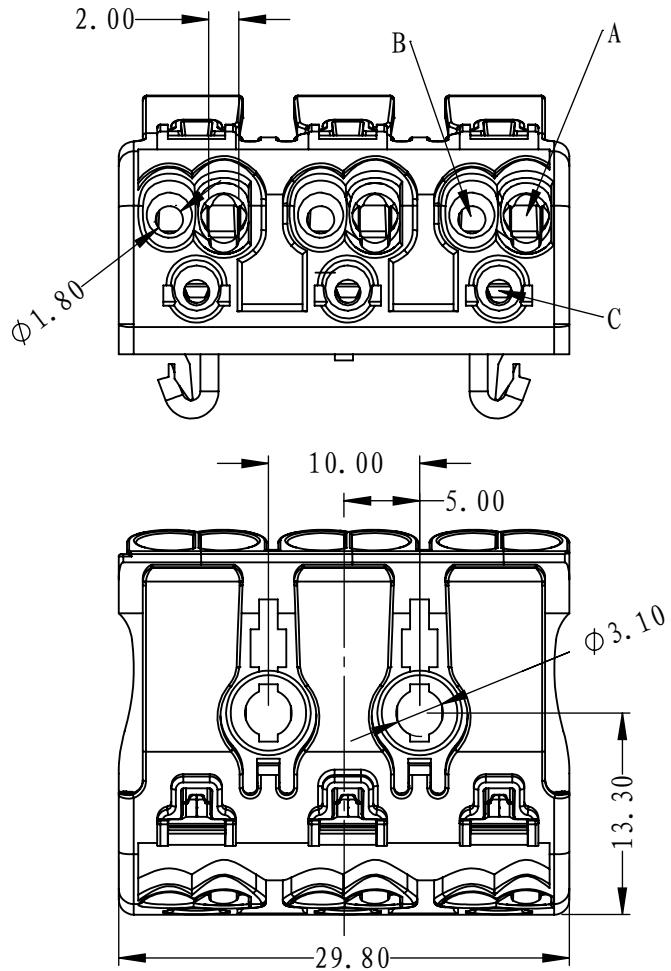
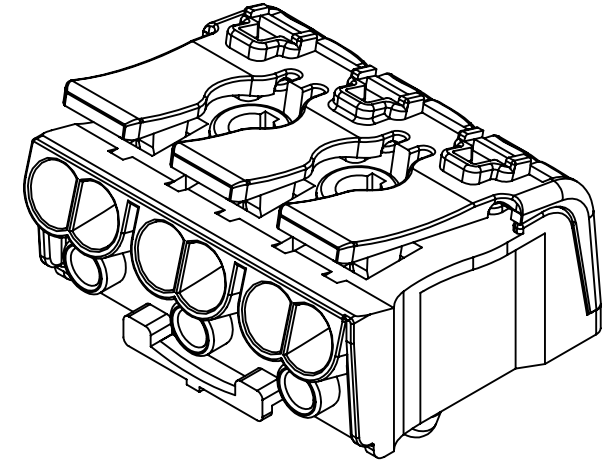
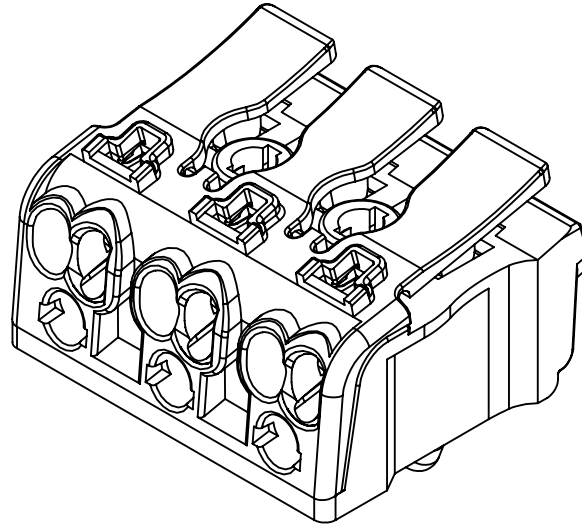
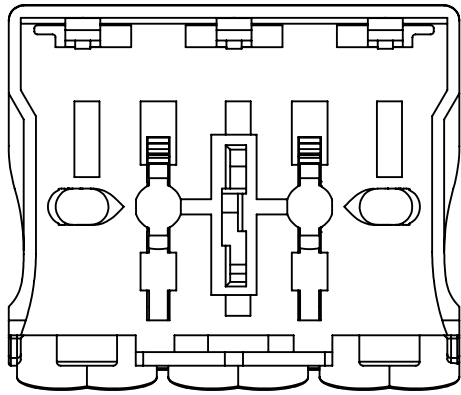

SERIAL NUMBER: Q/KR.C09-05-186

JIANGMEN
KREALUX ELECTRICAL APPLIANCES CO., LTD

MODEL NO:

P02-3J

DRAWN

DATE

EDITION

A

SCALE

2:1